

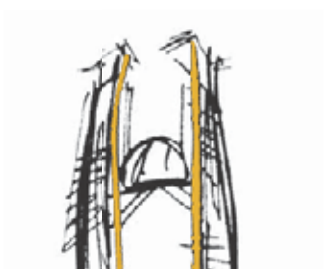

www.huttonsgroup.com



www.huttonsgroup.com

www.huttonsgroup.com
www.huttonsgroup.com
www.huttonsgroup.com
www.huttonsgroup.com

Pure Inspiration
www.huttonsgroup.com

Welcome to Lincoln Suites – an iconic freehold residence inspired by a world of luxury, located in Novena, one of the most sought-after residential enclaves in Singapore.

Thoughtfully designed with clean, sleek architectural lines, Lincoln Suites exudes pure sophistication and style. Two elegant towers offer a choice of living accommodation to suit all lifestyles. Coupled with an impressive array of recreational facilities carefully blended with stunning landscaping and glorious vistas.

Lincoln Suites is your inspirational home for the lifestyle of your dreams.





Pure Entertainment
www.huttonsgroup.com

Lincoln Suites offers you the perfect location for entertainment and pleasure.

Take delight in being next to the one-stop entertainment and dining hub of Novena where you will find glittering malls like Novena Square, Square 2, Velocity at Novena and United Square. Orchard Road, Singapore's main shopping destination is a mere 5 minutes' drive away. Shop at the most fashionable boutiques. Dance to the latest beat at chic clubs and nightspots. Treat yourself to a rejuvenating massage or a refreshing stroll.

Lincoln Suites offers you an abundance of sophisticated pleasures.

www.hullitegroup.com

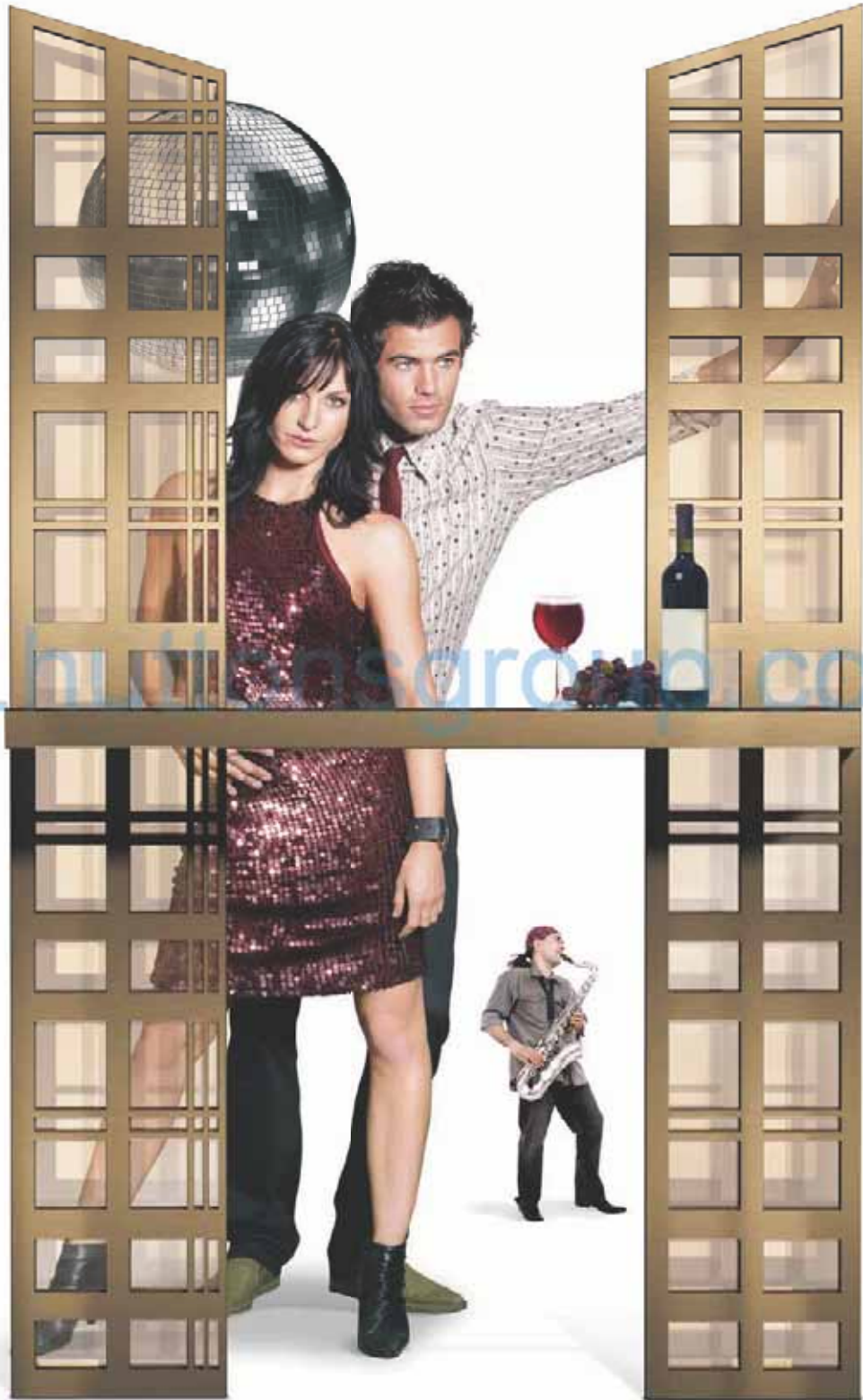



Pure Convenience
www.huttonsgroup.com

At Lincoln Suites, the entire world is at your doorstep.

Your children's educational needs will be easily met by Lincoln Suites' close proximity to prestigious schools such as St. Joseph's Institution (Junior) and Anglo-Chinese Primary School. Commuting is a breeze with the residence's easy access to Novena MRT Station, the Pan Island Expressway and the Central Expressway. Food connoisseurs will be delighted with the abundant treats from Newton Food Centre and the many famous eateries around Balestier. A medical hub which includes Novena Medical Centre is literally around the corner.

Lincoln Suites is truly at the heart of it all.



www.buitoni.com





Lincoln Suites' impressive drop off plaza ensures that every home coming is a truly grand arrival.



www.jaguar.com

Pure Fun
www.huttonsgroup.com

Enjoy a life of pure fun with the Leisure Wing and Family Wing at Level 5

Lincoln Suites is a self-contained world of luxury, refinement and pleasure with a superb selection of recreational facilities spread out over two floors for your delight. The Leisure Wing and Family Wing at Level 5 offer the perfect setting for the entire family, including a 360° Spa Pool, 50m Lap Pool, Wet Sun Deck, Fun Pool and Play Area. Should you be in the mood for a refreshing drink surrounded by a cool, casual ambience, the Chill-Out Zone awaits your pleasure.

www.fruitmarket.com





Lounge about or swim to your heart's content in the luxurious pool.

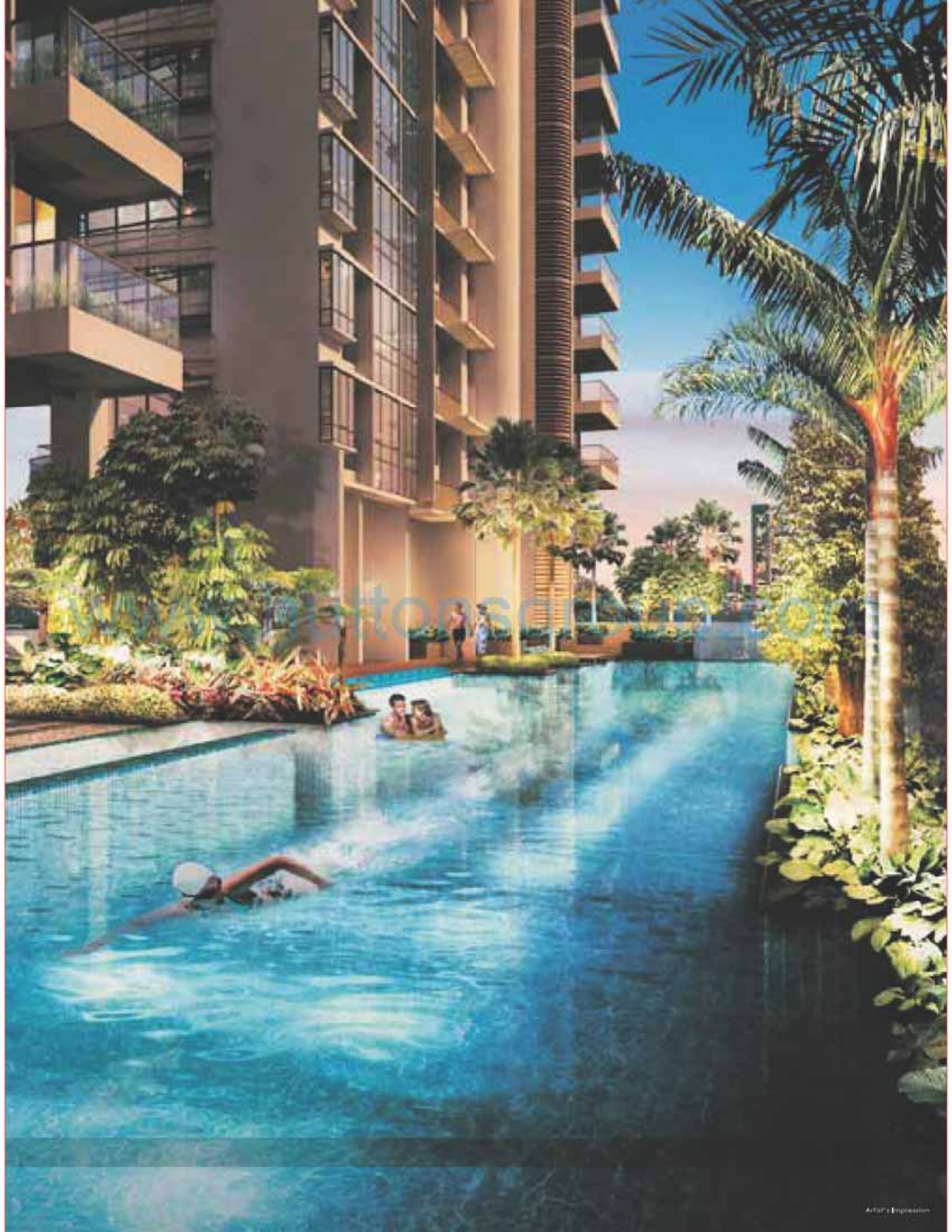

Antons

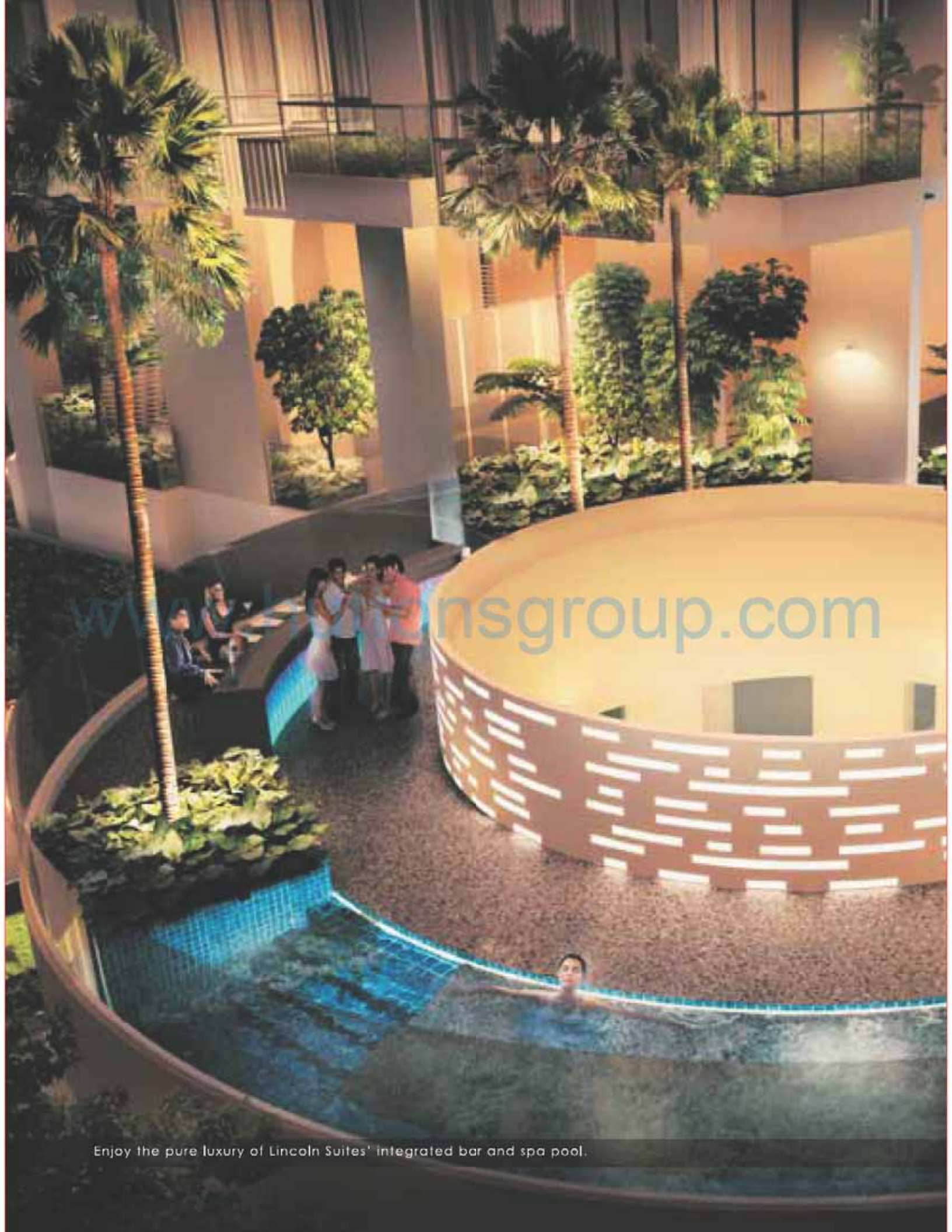

nsgroup.com

Enjoy the pure luxury of Lincoln Suites' integrated bar and spa pool.



www.hurt

CO

Pure Privilege
www.huttonsgroup.com

Lincoln Suites offers you an exclusive world of privilege and pleasure.

Ascend to Level 24 and step into an exclusive, club-like environment that presents you with a wealth of indulgences at the Wellness Wing and Club Wing. Melt away the cares of the day at the Thermo Spa with Hot and Cold Jacuzzis. Stroll over to the Massage Therapeutic Deck and pamper your body with a Curative Massage. Lincoln Suites' signature Sky Gym comes equipped with the latest workout equipment and inspiring views of the city making it the perfect environment for the body and soul. Retreat to the Club Wing at sunset for intimate get-togethers and sophisticated parties. Whip up your signature dishes at the Gourmet Kitchen or thrill your guests by entertaining them at the Alfresco Dining Area.

Whatever your requirements, Lincoln Suites offers a lifestyle experience like no other.



Be inspired as you enjoy the city view while you work out at the sky gym.



Relax at the Terrace Spa with Hot and Cold Jacuzzis.

Savour great moments at the Gourmet Kitchen.



Your home of abundant luxury at Lincoln Suites.

Designed to complement your exquisite taste for the finest in life, every apartment at Lincoln Suites combines modern, stylish features with classic, spacious proportions. Offering a broad selection of studio, 1, 2, 3, and 4-bedroom apartments, duplexes and penthouses, every individual home at Lincoln Suites is replete with superb finishing, fixtures and fittings.

Lincoln Suites is the perfect representation of your exquisite taste.





www.huttonsgroup.com

Pure Vision
www.huttonsgroup.com

To create only the best for you.

Inspired by a common vision, Koh Brothers Development Pte Ltd, Lian Beng Realty Pte Ltd, Heeton Homes Pte Ltd and Kim Seng Heng Realty Pte Ltd and have combined their vast experience and unique skills to create Lincoln Suites – an iconic twin tower condominium of unprecedented luxury in the heart of Novena.



**Koh Brothers
Development Pte Ltd**

A Member of Koh Brothers Group Limited

Koh Brothers, a well-established construction, property development and specialist engineering solutions provider has 43 subsidiaries, five JV companies and two associated companies in Singapore, PRC, Indonesia, Malaysia and Vietnam. A name synonymous with quality and innovation, Koh Brothers' remarkable resume includes Sun Plaza and The Lumos (in partnership with Heeton Holdings Limited), Bungalows @ Caldecott, Montana, The Sierra, The Capri, Starville and Florenza.

www.kohbrothers.com



**Lian Beng
Realty Pte Ltd**

A Member of Lian Beng Group Limited

Established in 1973, Lian Beng Group has become a major player in Singapore's building and construction industry, with integrated civil engineering and other construction support capabilities. Along with recently completed prestigious developments such as Emerald Hill Enclaves and the Ritz-Carlton Residences, the Group's past notable projects include 8 @ MI, Sophia, Grand Duchess and Sixth Avenue Residences. In addition, Lian Beng Group is providing a wide spectrum of services related to the construction of the basement of the highly anticipated Marina Bay Integrated Resort.

www.lianbeng.com.sg



**Heeton Homes
Pte Ltd**

A Member of Heeton Holdings Limited

Since its inception in 1973, Heeton Holdings Limited has been renowned for its unique property developments aimed at discerning home buyers. Today, Heeton Holdings Limited is a public listed company, LynnsVile 331 and Juluca (both along Pasir Panjang Road), DLV (on the site of the former Chinese Embassy), The Bement@Stevens, Sun Plaza and The Lumos (both in partnership with Koh Brothers Group Limited) are some of its latest high-profile developments.

www.heeton.com



**Kim Seng Heng
Realty Pte Ltd**

A Member of KSH Holdings Limited

With over 28 years of experience in the property development industry and the building and construction industry, KSH Holdings has built a strong presence in Singapore, Malaysia and PRC. One* 15 Marina Club, The Berth by the Cove, Montview, Thomson Euro Asia, the extension of Mustafa Shopping Centre and Nanyang Polytechnic are just some of the completed projects in its impressive portfolio. In the pipeline is a new 30-storey condominium development at Merryn Road.

www.kimsengheng.com

While every reasonable care has been taken in preparing this brochure, the developer and its agents cannot be held for any inaccuracies/omissions. All statements are believed to be correct but are not to be regarded as statements or representation of facts. All information and specifications are current at the time of print and subject to change as may be required without prior notice and cannot form part of the contract. Visual representations including models, drawings, illustrations, photographs and of renderings portray artistic impressions only and are not to be taken as representations of fact. Floor areas and other measurements are approximate only and are subject to final survey. The Sale & Purchase Agreement shall form the entire contract between the Developer and the Purchaser and shall supersede all statements, representations or promises made prior to the signing of the Sale & Purchase Agreement and shall not be modified by any statements, representations or promises made by the Developer and its Marketing Agents.

Developer: Philipp Pte Ltd • Co Reg No. 200702146 • Developer's Licence No. C0483 • Tenure of Land: Strata In Fee Simple (Freehold) • Legal Description: LOT 827A 33 28 of (D'Almeida) Avenue • Expected date of delivery of vacant possession: 31 December 2014 • Expected date of legal completion: 31 December 2017 or 3 years after notice of vacant possession whichever is earlier • Building Plan No. A1369-00467-20074P01 dated 3rd April 2009

Schematic Diagram

UNIT NO. STOREY	HOUSE NO. 1		HOUSE NO. 3					
	01	02	03	04	05	06	07	08
#30	PH3		PH1			PH2		
#29	PH3		PH1			PH2		
#28	*DP2	*DP1	C2	A2	C3	*C4	*S4	*S3
#27	*DP2	*DP1	C2	A2	C3	*C4	*S4	*S3
#26	*DP2	*DP1	C2	A2	C3	*C4	*S4	*S3
#25	*DP2	*DP1	C2	A2	C3	*C4	*S4	*S3
#24	SKY TERRACE		SKY TERRACE					
#23	*DIS	*C1S	C2	A1	C3	*C4	*S2	*S1
#22	*DIS	*C1S	C2	A1	C3	*C4	*S2	*S1
#21	*DIS	*C1S	C2	A1	C3	*C4	*S2	*S1
#20	*DIS	*C1S	C2	A1	C3	*C4	*S2	*S1
#19	*D1	*C1	B3	A1	B2	*B1	*S2	*S1
#18	*D1	*C1	B3	A1	B2	*B1	*S2	*S1
#17	*D1	*C1	B3	A1	B2	*B1	*S2	*S1
#16	*D1	*C1	B3	A1	B2	*B1	*S2	*S1
#15	*D1	*C1	B3	A1	B2	*B1	*S2	*S1
#14	*D1	*C1	B3	A1	B2	*B1	*S2	*S1
#13	*D1	*C1	B3	A1	B2	*B1	*S2	*S1
#12	*D1	*C1	B3	A1	B2	*B1	*S2	*S1
#11	*D1	*C1	B3	A1	B2	*B1	*S2	*S1
#10	*D1	*C1	B3	A1	B2	*B1	*S2	*S1
#09	*D1	*C1	B3	A1	B2	*B1	*S2	*S1
#08	*D1	*C1	B3	A1	B2	*B1	*S2	*S1
#07	*D1	*C1	B3	A1	B2	*B1	*S2	*S1
#06	*D1	*C1	B3	A1	B2	*B1	*S2	*S1
#05	SKY TERRACE							
#01 TO #04	CARPARK PODIUM AT LEVEL 1, 1A, 2, 2A, 3 & 4							

Remarks

- *UNIT: Denotes balcony/planter/bay window with additional perforated mesh in front.
- Stack Nos 01, 02 & 07 have an external elevation feature adjacent to the units.
- For #23-02 & #23-03 one of the elevation has an external truss supports for sky gym.
- Stack Nos 01, 05 & 06 have an external beam located on 6th, 9th, 12th, 15th, 18th & 21th storey.

UNIT LEGEND

S1	STUDIO	18
S2	STUDIO	18
S3	STUDIO	04
S4	STUDIO	04

A1	1 BEDROOM	18
A2	1 BEDROOM	04

B1	2 BEDROOM	14
B2	2 BEDROOM	14
B3	2 BEDROOM	14

C1	3 BEDROOM	14
C2	3 BEDROOM	08
C3	3 BEDROOM	08
C4	3 BEDROOM	08
C1S	3 BEDROOM + STUDY	04

D1	4 BEDROOM	14
DIS	4 BEDROOM + STUDY	04
DP1	3 BEDROOM DUPLEX	02
DP2	4 BEDROOM DUPLEX	02

PH1	PENTHOUSE	01
PH2	PENTHOUSE	01
PH3	PENTHOUSE	01

TOTAL: 175 Units

1st Storey Site Plan



Legend:

- 1** Water Features/Concierge
- 2** Jardin Paths
- 3** Sunken Multi-Games Court

www.hongkonggroup.com

All plans are not to scale and subject to changes as may be approved by relevant authorities. All floor areas are approximate only and are subject to final survey.

5th Storey Sky Terrace



24th Storey Sky Terrace

Club Wing



Wellness Wing



Legend:

- Club Wing**
- 23 Alfresco Dining
 - 24 The Italian Dining
 - 25 Gourmet Kitchen
 - 26 The Intimate Booth
 - 27 The Wine Room
 - 28 Recreation Corner
 - 29 The Garden
 - 30 The Living Room

- Wellness Wing**
- 31 Sky Gym
 - 32 Outdoor Gym
 - 33 Meditation Corner
 - 34 Yoga Corner
 - 35 Changing Room
 - 36 Steam Room
 - 37 Thermal Spa with Hot & Cold Jacuzzis
 - 38 Massage/Aroma Therapeutic Deck

Studio

TYPE S1

Unit #06-08 to #23-08
43 sq m / 463 sq ft



www.huttonsgroup.com

Studio

TYPE S2

Unit #06-07 to #23-07
44 sq m / 474 sq ft

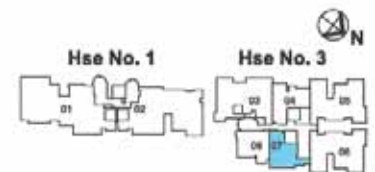

Studio

TYPE S3

Unit #25-08 to #28-08
45 sq m / 484 sq ft



www.huttonsgroup.com

Studio

TYPE S4

Unit #25-07 to #28-07
44 sq m / 474 sq ft



1 Bedroom

TYPE A1

Unit #06-04 to #23-04
49 sq m / 527 sq ft

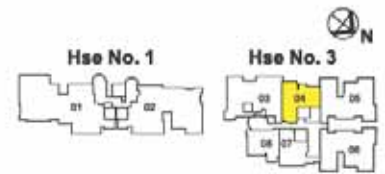

www.huttonsgroup.com

1 Bedroom

TYPE A2

Unit #25-04 to #28-04
50 sq m / 538 sq ft

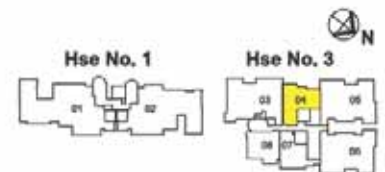

2 Bedroom

TYPE B1

Unit #06-06 to #19-06
96 sq m / 1033 sq ft

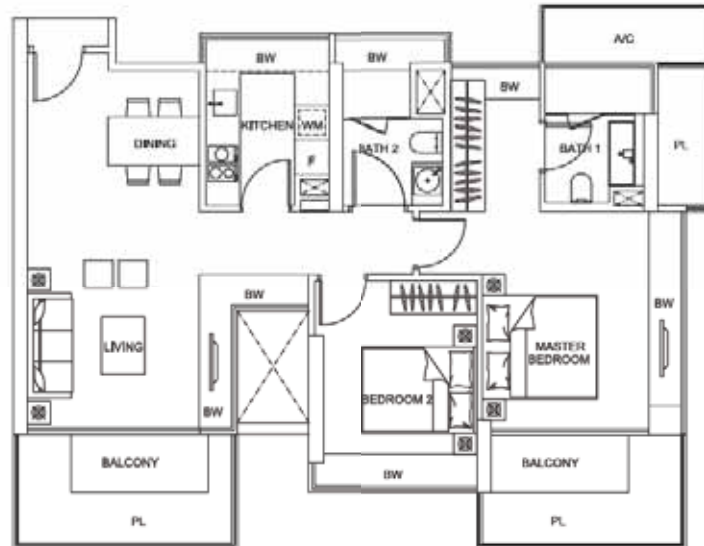
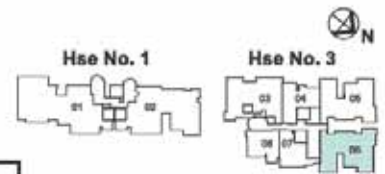

www.huttonsgroup.com

2 Bedroom

TYPE B2

Unit #06-05 to #19-05
97 sq m / 1044 sq ft

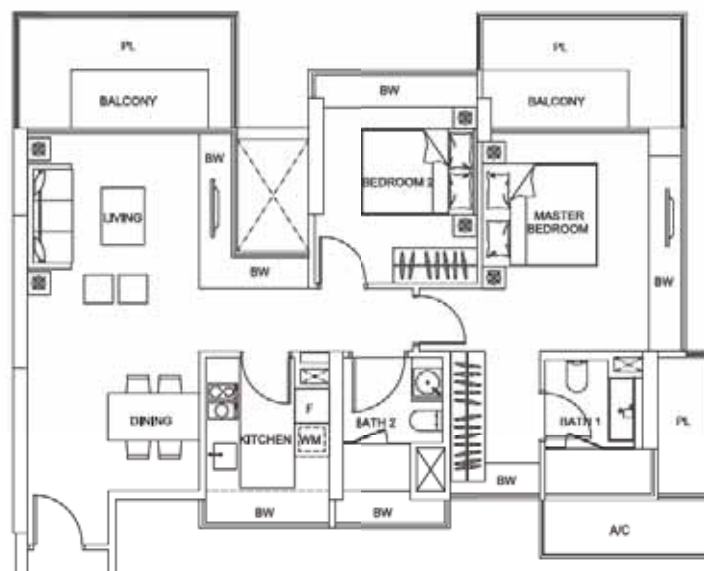

2 Bedroom

TYPE B3

Unit #06-03 to #19-03

100 sq m / 1076 sq ft

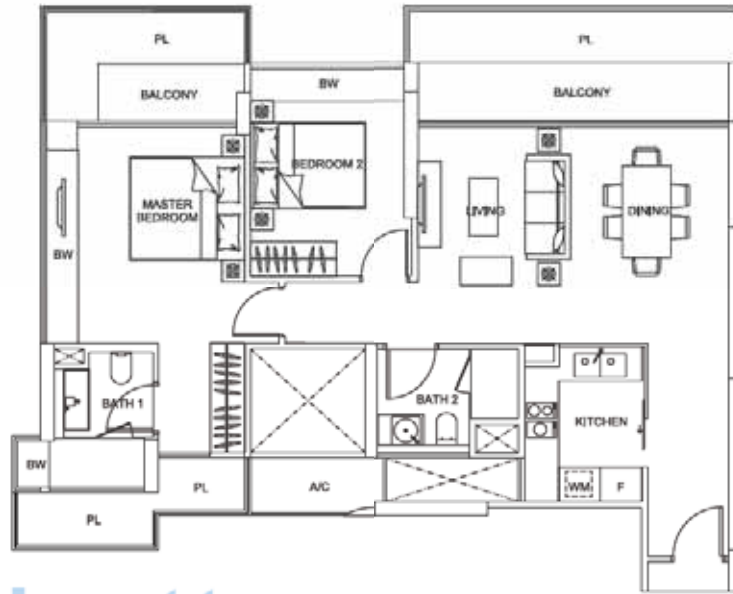

www.huttonsgroup.com

3 Bedroom

TYPE C1

Unit #06-02 to #19-02

145 sq m / 1561 sq ft

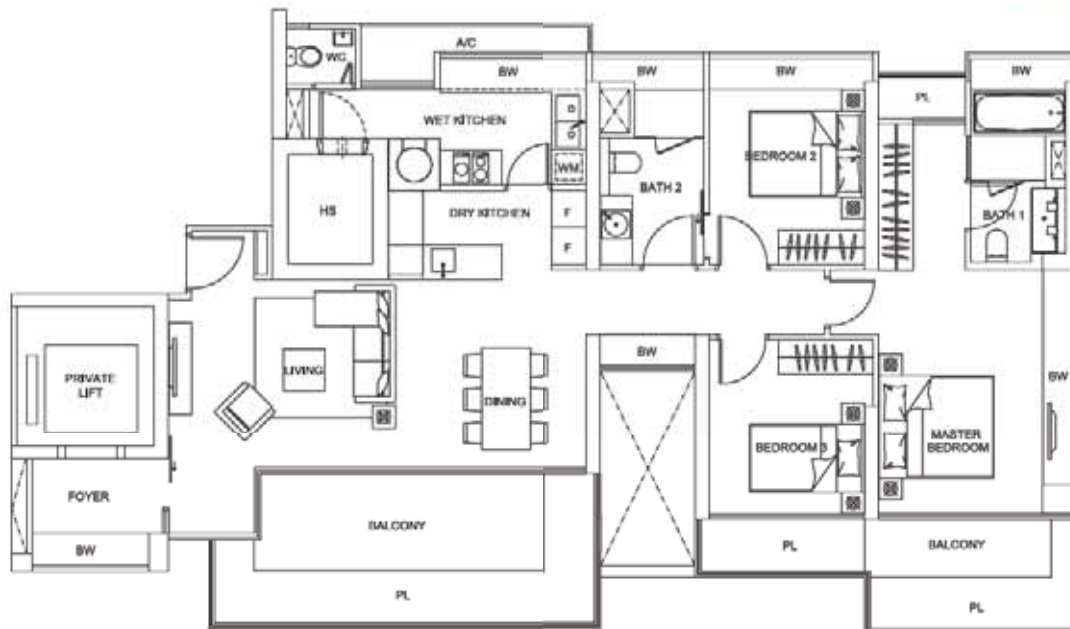

3 Bedroom + Study

TYPE C1S

Unit #20-02 to #23-02
150 sq m / 1615 sq ft

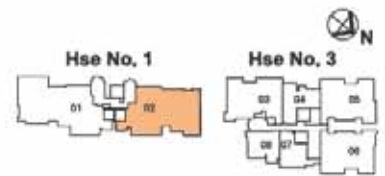
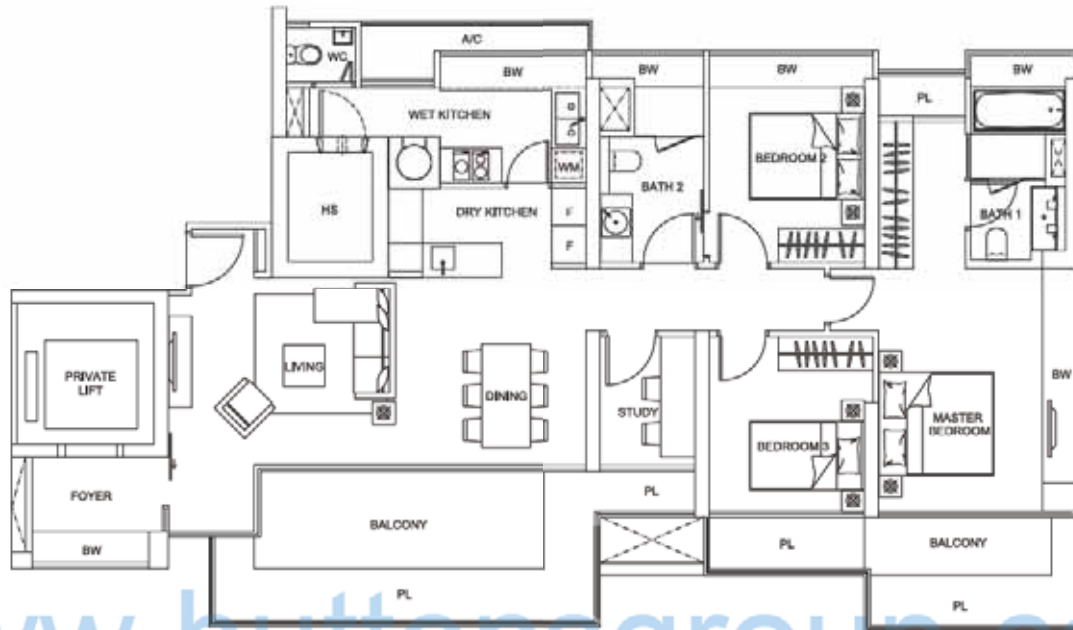

www.huttonsgroup.com

3 Bedroom

TYPE C2

Unit #20-03 to #23-03
Unit #25-03 to #28-03
104 sq m / 1119 sq ft

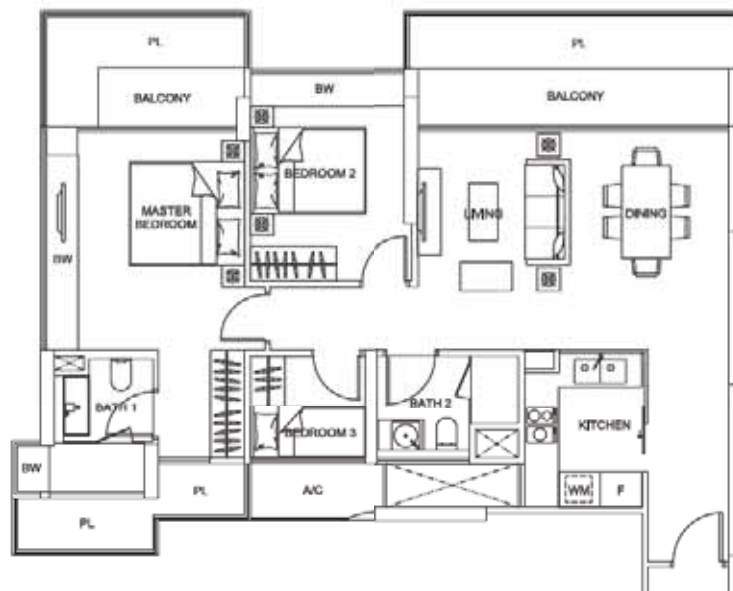

3 Bedroom

TYPE C3

Unit #20-05 to #23-05

Unit #25-05 to #28-05

103 sq m / 1109 sq ft

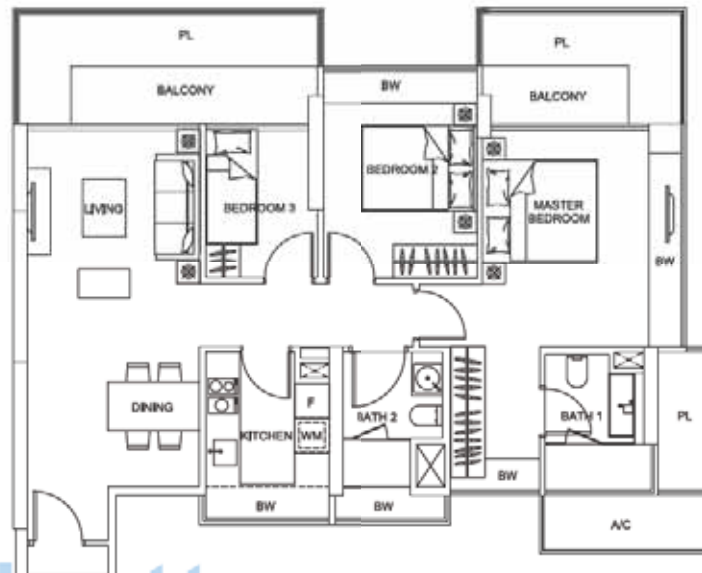

www.huttonsgroup.com

3 Bedroom

TYPE C4

Unit #20-06 to #23-06

Unit #25-06 to #28-06

102 sq m / 1098 sq ft

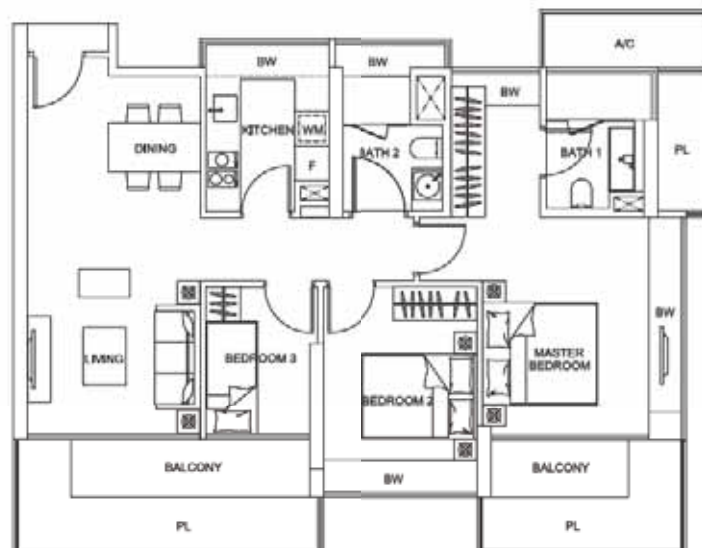
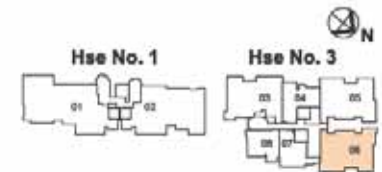

4 Bedroom

TYPE D1

Unit #06-01 to #19-01
167 sq m / 1798 sq ft

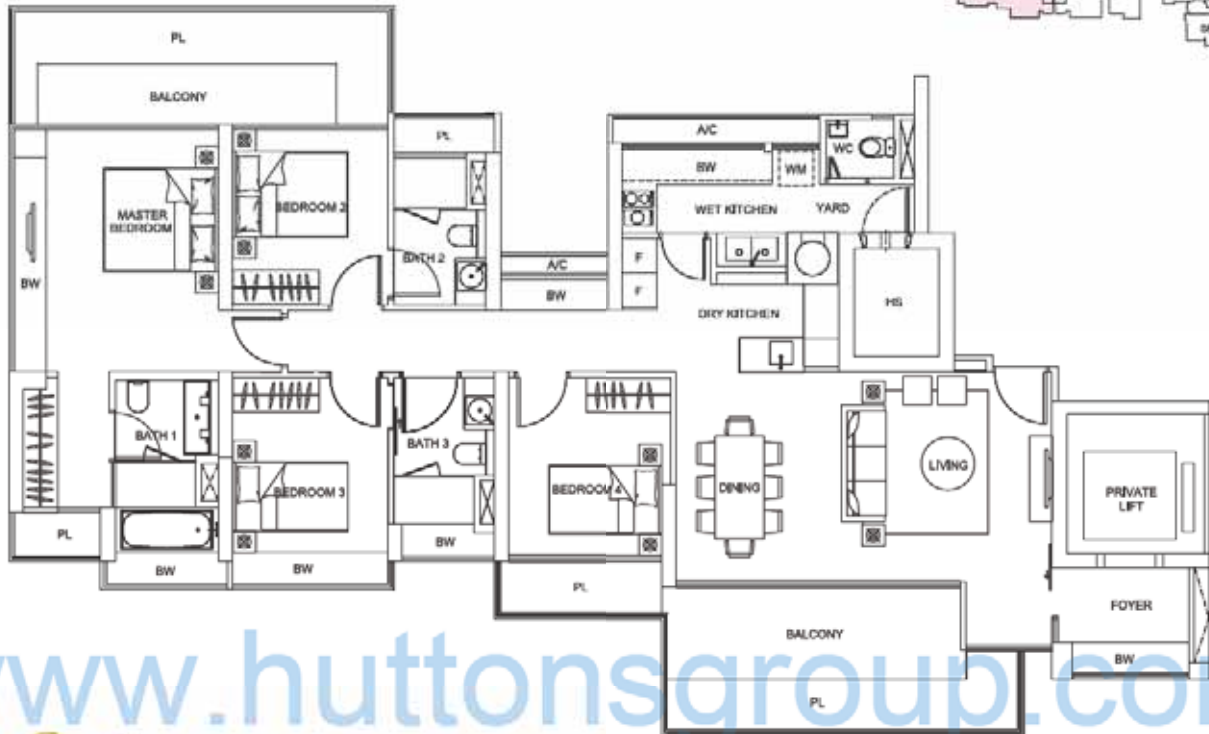

www.huttonsgroup.com

4 Bedroom

TYPE D1S

Unit #20-01 to #23-01
171 sq m / 1841 sq ft

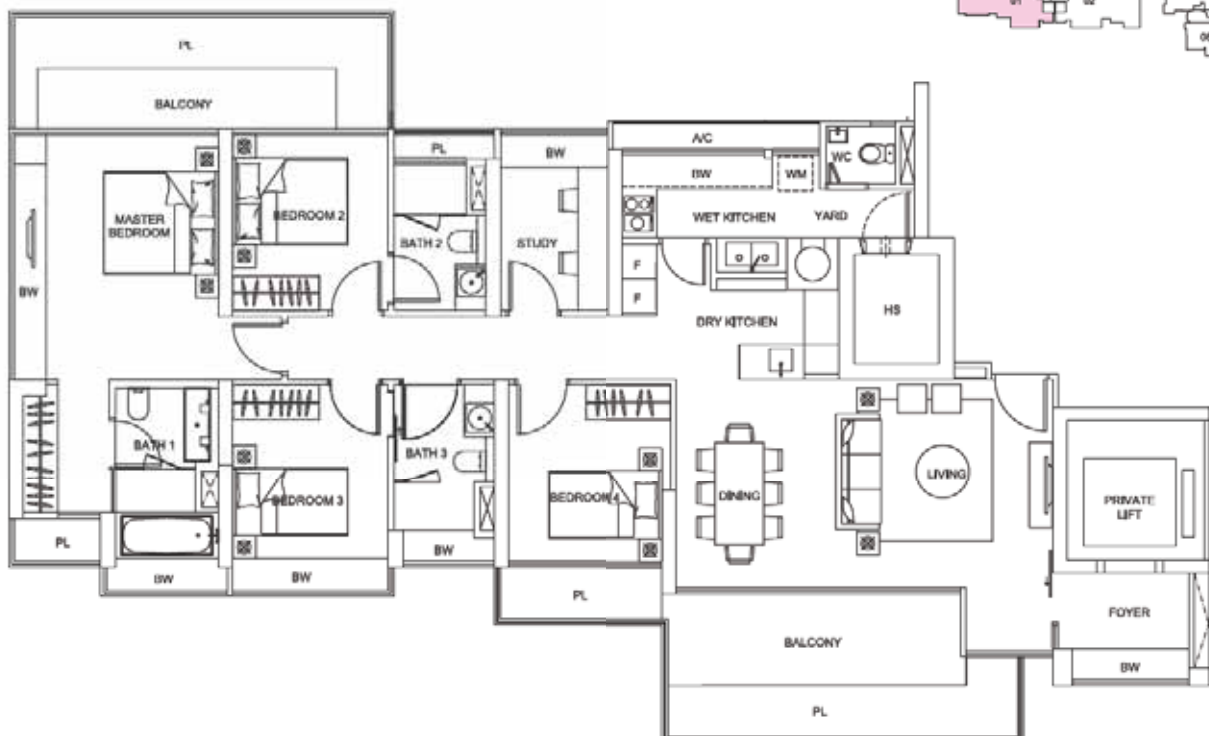

3 Bedroom Duplex

TYPE DPI

Unit #25-02 and #27-02

243 sq m / 2616 sq ft

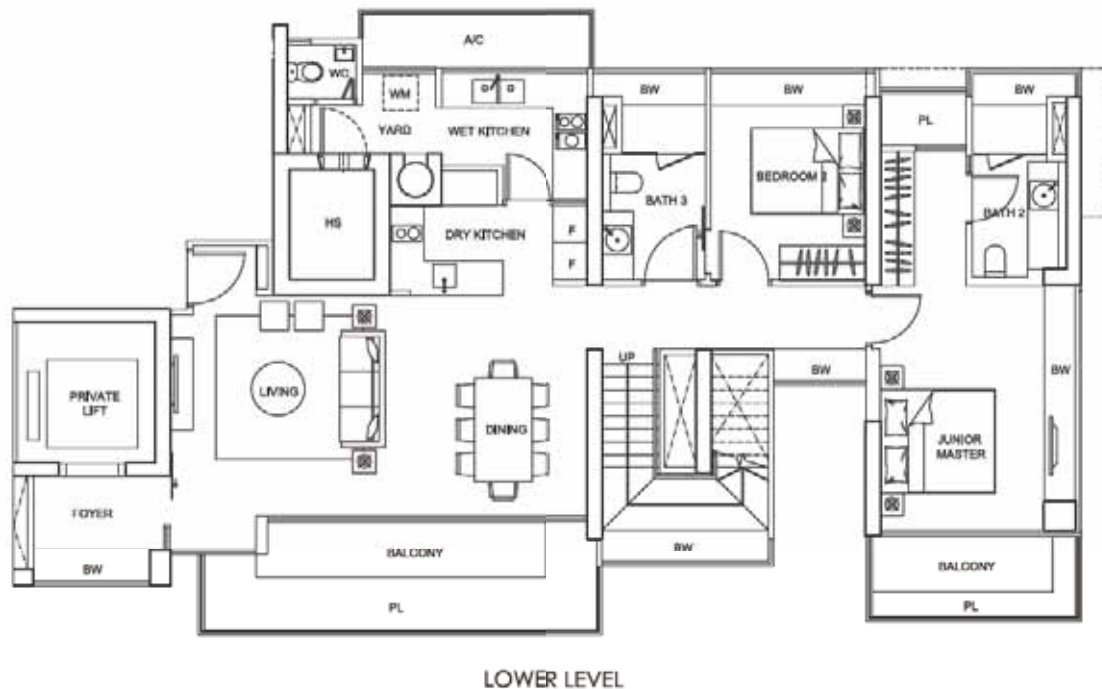
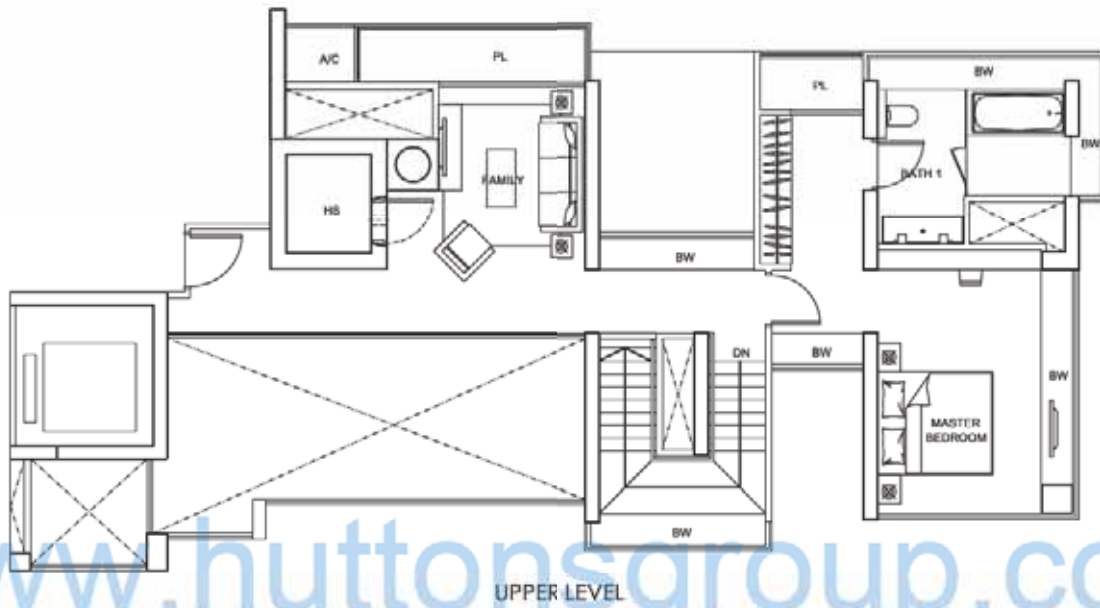
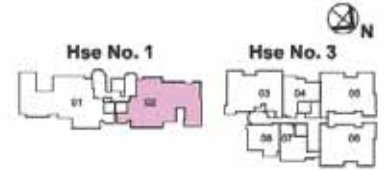

4 Bedroom Duplex

TYPE DP2

Unit #25-01 to #27-01

282 sq m / 3035 sq ft

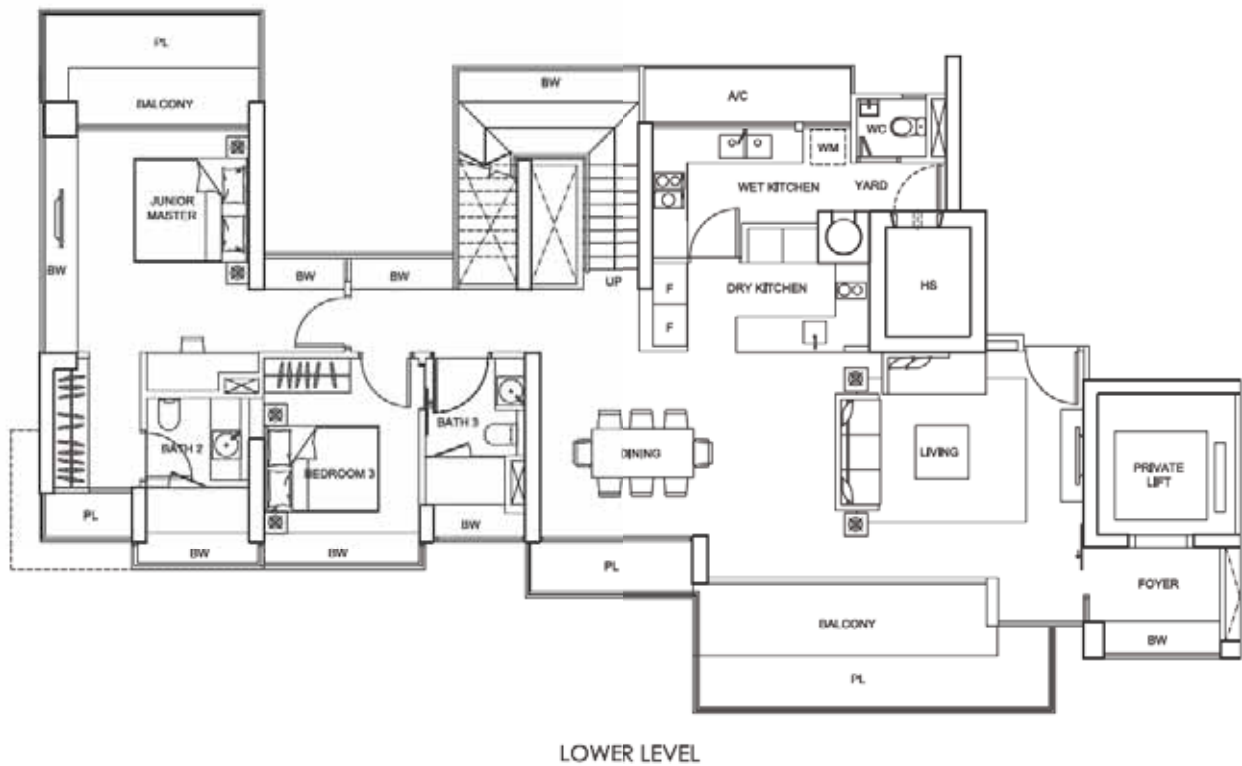
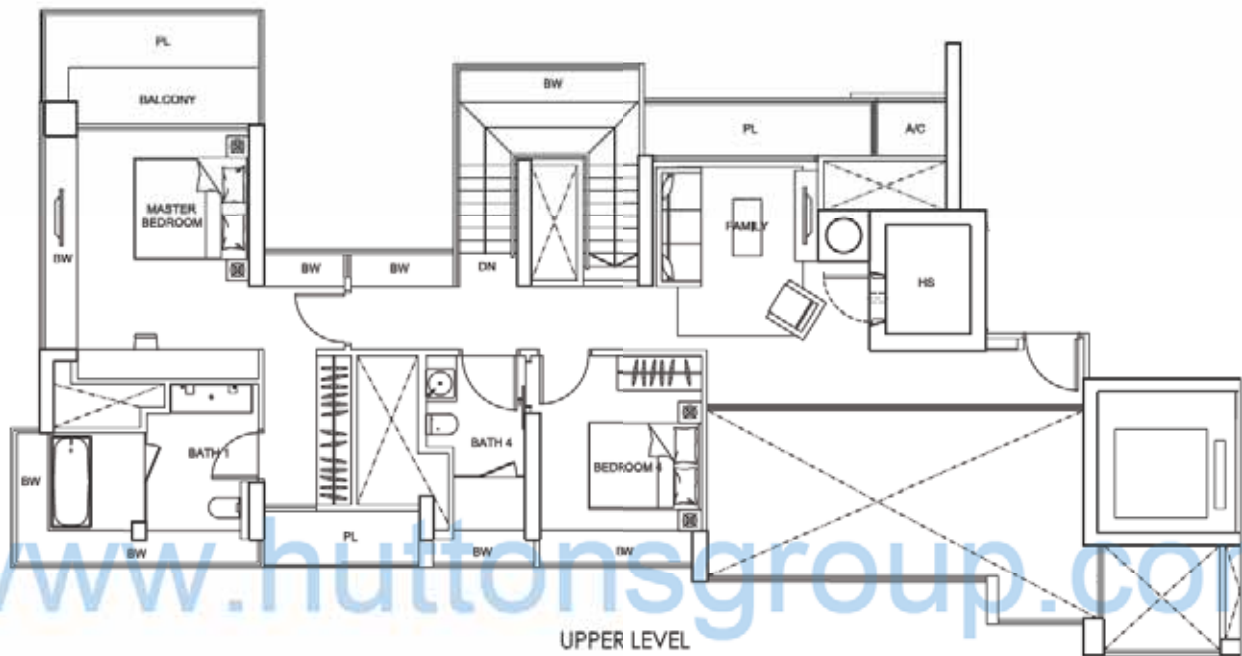
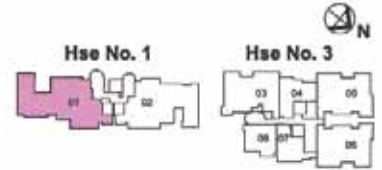

Penthouse

TYPE PH1

Unit #29-03

451 sq m / 4855 sq ft

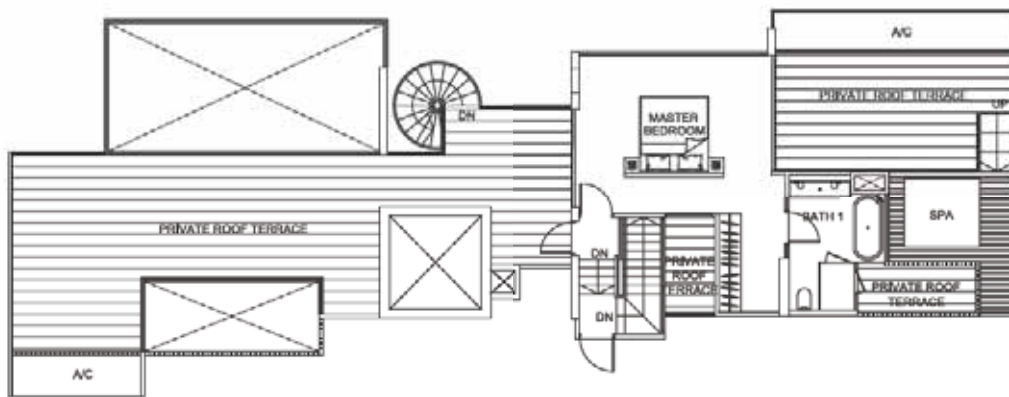
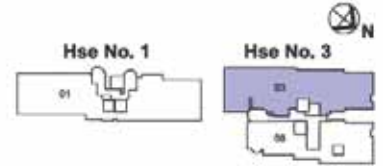

UPPER LEVEL

www.huttonsgroup.com

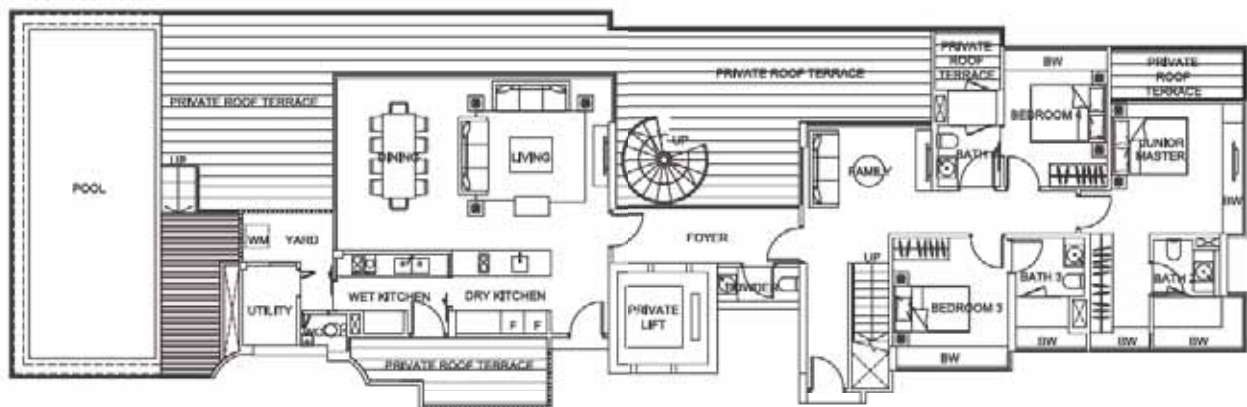

LOWER LEVEL

Penthouse

TYPE PH2

Unit #29-08

344 sq m / 3703 sq ft

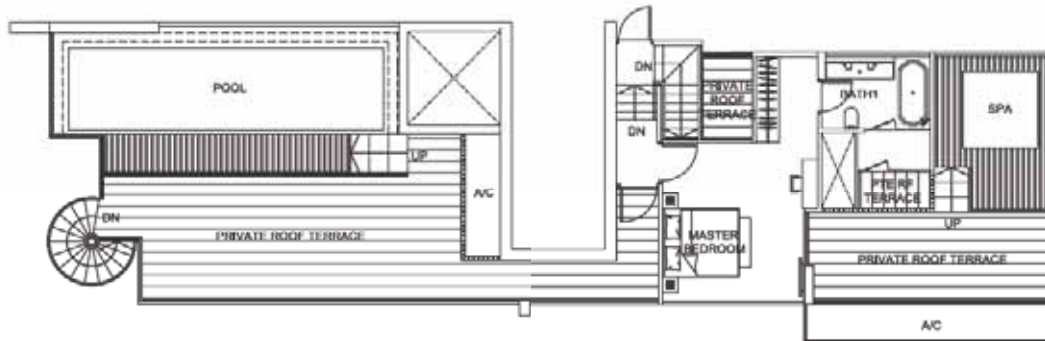
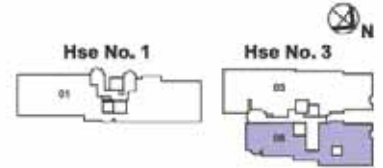

UPPER LEVEL

www.huttonsgroup.com

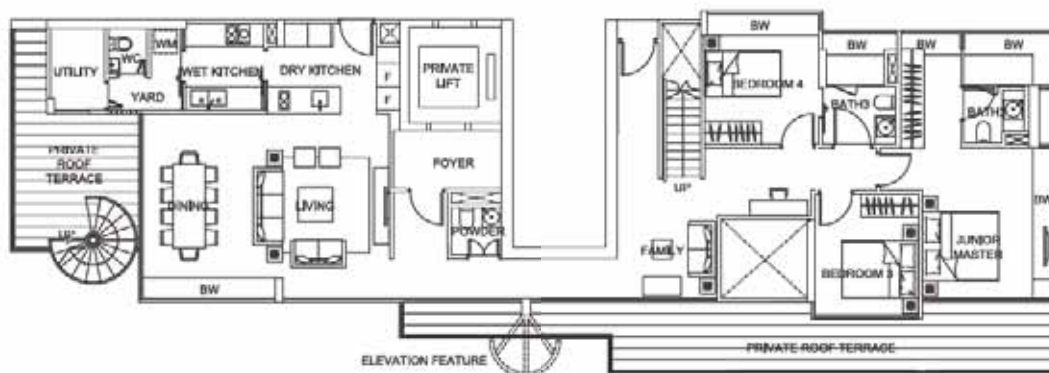

LOWER LEVEL

Penthouse

TYPE PH3

Unit #29-01

513 sq m / 5522 sq ft

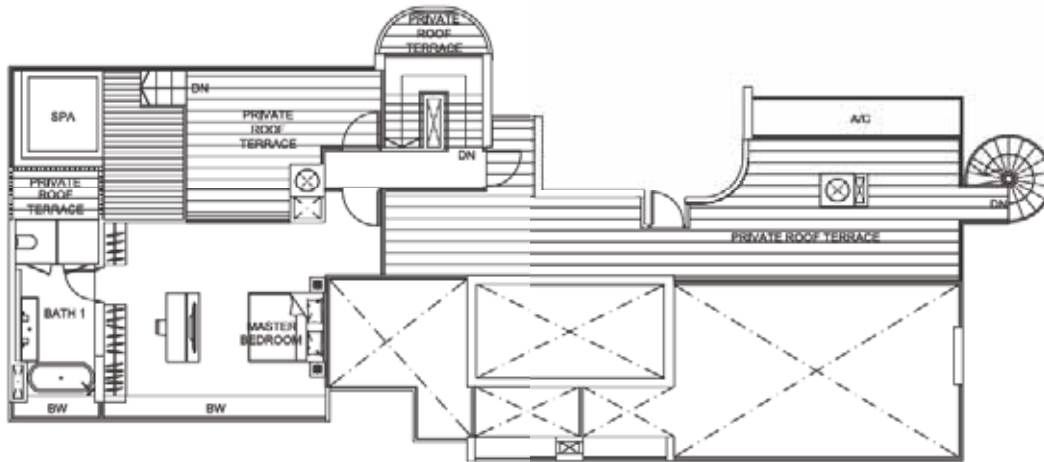
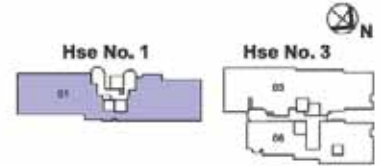

www.huttonsgroup.com

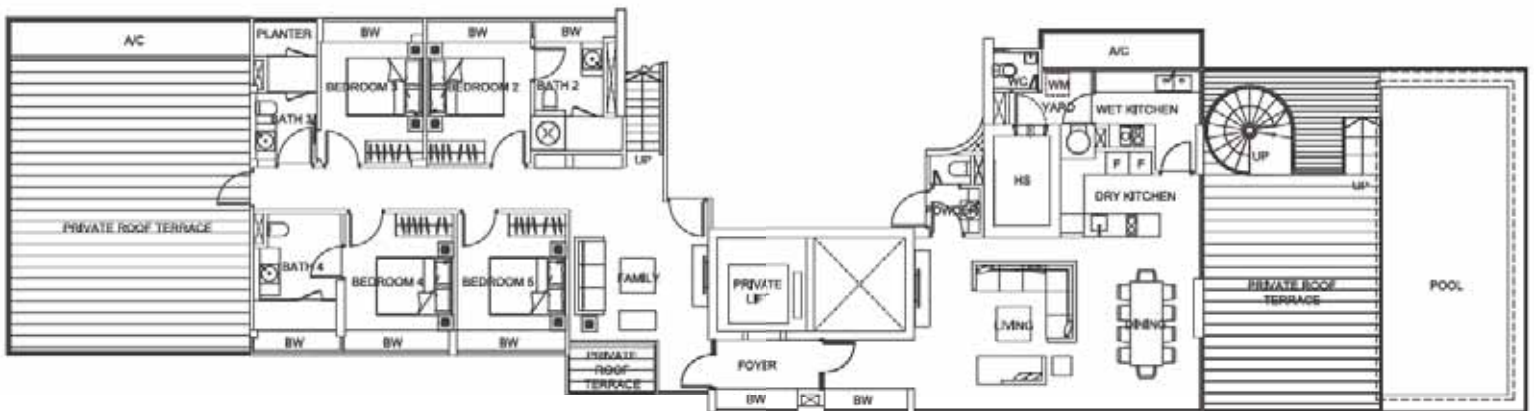

Specifications

1. FOUNDATION

Reinforced concrete piles and/or an approved foundation system

2. SUB-STRUCTURES AND SUPERSTRUCTURE

Reinforced concrete and/or structural steel to Engineer's specification

3. WALLS

- (a) External Walls : Reinforced concrete wall and/or brick wall
- (b) Internal Walls : Reinforced concrete wall and/or brick wall and/or concrete blocks and/or drywall plasterboard partition system

4. ROOF

Reinforced concrete and/or steel roof with appropriate waterproofing system and insulation for apartments

5. CEILING

(a) Apartments

- i) Living, Dining, Foyer, Kitchen, Dry and Wet kitchen, Yard, Bedrooms, Study, Household Shelter, Terrace, Store and other areas : Skim coating with or without plaster ceiling boards and/or moisture resistant fibrous plaster ceiling board with or without box-ups to designated areas
- ii) Bathrooms, WC, Lift lobbies, at apartment floors : Moisture resistance fibrous plaster ceiling boards with or without box-ups to designated areas

(b) Common Areas

- i) Carpark floors, staircases, M&E services rooms/shaft and utilities : Skim coating
- ii) Lift lobby : Fibrous plaster ceiling board

6. FINISHES

(a) (1) Wall – For Apartment Units

- (i) Living, Dining, Bedrooms, Study, Household Shelter, Yard, Passageway, Store, Foyer and other areas : Cement & sand plaster and/or skim coat
- (ii) Kitchen, Wet Kitchen & Dry Kitchen : Homogenous and/or ceramic tiles (to exposed area only) and/or cement & sand plaster and/or skim coat
- (iii) Bathrooms : Stone finish and/or ceramic tiles and/or homogenous tiles
- (iv) WC : Ceramic tiles
- (v) Roof Terrace : Cement & sand plaster and/or skim coat

(a) (2) Wall – External (Common Areas)

- (i) External walls including Recreation Common Areas at 1st, 5th & 24th storey : Cement & sand plaster and/or skim coat and/or texture finished feature walls

(a) (3) Wall – Internal (Common Areas)

- (i) Corridors, Staircases, Landing and Other Areas : Cement & sand plaster and/or skim coating
- (ii) 1st, 5th & 24th Storey Lift Lobby : Marble and/or stone finish and/or marble tiles and/or homogenous tiles to designated areas. Cement and sand plaster and/or skim coating to other areas

(b) (1) Floor – For Apartment Units

- (i) Entrance Foyer, Living, Dining, Family and Dry Kitchen : Marble and/or stone finish with matching skirting
- (ii) Bedrooms, Study and Internal Staircase : Timber flooring with Timber skirting
- (iii) Bathrooms : Marble and/or stone finish and/or homogenous tiles
- (iv) Balcony, Kitchen, Wet Kitchen, WC, Household Shelter, Yard, Store and Roof Terrace : Homogenous tiles and/or ceramic tiles with matching skirting

(b) (2) Floor – Common Areas

- (i) 1st, Deck 1A, 2nd, Deck 2A, 3rd, 4th, 5th & 24th Storey, Lift Lobby : Marble and/or stone finish and/or homogenous tiles with matching skirting
- (ii) Staircases including landing and corridors at 1st storey carparking deck, 5th & 24th storey and mid landings leading to Deck 1A, 6th & 25th storey : Marble and/or stone finish and/or homogenous tiles with matching skirting
- (iii) Other Common Areas : Cement & sand screed and staircases to complete with grooves lines to staircase treads edge
- (iv) Handicapped Toilet : Homogenous tiles

(c) (i) Bay Windows – (For Apartment Units) : Cement and sand plaster finish

(ii) Bay windows at Foyer & Master Bathrooms : Marble and/or stone finish and/or homogenous tiles and/or ceramic tiles

7. WINDOWS

(a) Powder-coated aluminium-framed casement and/or sliding windows and/or top-hung and/or fixed panel with clear or tinted glass or frosted glass

8. DOORS

- (a) (i) Main Entrance : Fire-rated Timber door
 - (ii) Foyer : Sliding Glass door or Swing Glass door
 - (iii) Bedrooms & Bathrooms : Timber door
 - (iv) Master Bath : Glass door with or without Timber frame
 - (v) Study : With or without Timber door
 - (vi) Kitchen/Wet Kitchen : Aluminium Frame Glass door (for external facing only) or Sliding Timber Frame glass door
 - (vii) WC : PVC Frame Acrylic Panel door
 - (viii) Store : Timber door
 - (ix) Household Shelter : Steel door
 - (x) Balcony, Planters, Yard & Roof Terrace : Powder-coated Aluminium Frame Sliding or Swing Glass doors
- (Note: Selected ironmongery shall be provided to all doors)

9. SANITARY FITTINGS

(a) Master Bathroom

- 1 wash basin and 2 mixer taps with granite and/or solid surface vanity top (only 1 basin mixer tap provided for Unit Types S1, S2, S3, S4, A1, A2, B1, B2, B3, C2, C3 & C4 units)
- 1 long bath complete with bath mixer (For Unit Types C1, C1S, D1, D1S, DP1, DP2, PH1, PH2 & PH3 only)
- 1 water closet
- 1 toilet paper holder
- 1 towel rail
- 1 mirror
- 1 soap holder
- 1 integrated mixer with jets to shower area

(b) Bathrooms

- 1 basin and mixer tap
- 1 water closet
- 1 toilet paper holder
- 1 towel rail
- 1 mirror
- 1 soap holder
- 1 shower mixer

(c) WC

- 1 basin and tap
- 1 water closet
- 1 hand held shower spray
- 1 water tap with twin-head

(d) Yard

- 1 bib-tap

(e) Wet / Dry Kitchen

- 1 sink with mixer tap

(f) Roof Terrace

- 1 shower mixer tap (For Unit Types PH1, PH2 & PH3 only)
- Jacuzzi /Private Swimming Pool (For Unit Types PH1, PH2 & PH3 only)
- 1 bib-tap

10. ELECTRICAL INSTALLATION

SCHEDULE OF ELECTRICAL PROVISION

ITEM	UNIT TYPE																					
	S1	S2	S3	S4	A1	A2	B1	B2	B3	C1	C1S	C2	C3	C4	D1	D1S	DP1	DP2	PH1	PH2	PH3	
LIGHTING POINT	6	5	6	5	6	6	1	1	1	1	1	1	1	1	1	1	1	1	1	1	1	1
13A SWITCHED SOCKET OUTLET	13	13	13	13	13	13	19	19	19	28	30	21	21	21	33	35	34	39	39	37	42	
13A SWITCHED SOCKET OUTLET FOR WASHING MACHINE	1	1	1	1	1	1	1	1	1	1	1	1	1	1	1	1	1	1	1	1	1	1
WATER HEATER ISOLATOR	1	1	1	1	1	1	2	2	2	2	2	2	2	2	3	3	3	4	4	3	4	
AIRCON ISOLATOR	1	1	1	1	2	2	3	3	3	4	4	3	3	3	5	5	6	7	6	6	8	
SCV OUTLET	2	2	2	2	2	2	3	3	3	5	6	4	4	4	6	7	7	8	6	6	8	
TELEPHONE OUTLET	2	2	2	2	2	2	3	3	3	5	6	4	4	4	6	7	7	8	6	6	8	
COOKER HOOD POINT	1	1	1	1	1	1	1	1	1	1	1	1	1	1	1	1	1	1	1	1	1	1
COOKER HOB POINT	1	1	1	1	1	1	1	1	1	1	1	1	1	1	1	1	1	1	1	1	1	1
ELECTRIC OVEN POINT	1	1	1	1	1	1	1	1	1	1	1	1	1	1	1	1	1	1	1	1	1	1
AUDIO/VIDEO INTERCOM POINT	1	1	1	1	1	1	1	1	1	1	1	1	1	1	1	1	1	1	1	1	1	1
BELL PUSH C/W BELL POINT	1	1	1	1	1	1	1	1	1	1	1	1	1	1	1	1	1	1	1	1	1	1
JACUZZI POINT	0	0	0	0	0	0	0	0	0	0	0	0	0	0	0	0	0	0	0	0	1	1

NOTE: 1) All Isolators for CU are subjected to A/C equipment configuration

11. TV / TELEPHONE

Refer to Electrical Schedule for details

Specifications

12. LIGHTNING PROTECTION

In compliance with Singapore Standard CP 33: 1996

13. PAINTING

- (a) Internal Walls : Emulsion paint
(b) External Walls : Emulsion paint and/or textured coating finish to designated areas

14. WATER PROOFING

Water-proofing to floors of Kitchen, Wet Kitchen, Bathrooms, WC, Yard, Balcony, Planter Boxes, Terraces, Landscape Deck, Reinforced Concrete Flat Roof, Pool/Jacuzzi and Roof Terraces

15. Driveway and Carpark

- (a) External Driveway : Selected stone finish and/or textured concrete and/or reinforced concrete slab
(b) Driveway and Carpark : Reinforced concrete slab with hardener

16. Recreation Facilities

- (a) 1st Storey : Water Features/Concierge
Fitness Station
Jardin Paths
Sunken Multi-Games Court
- (b) 5th Storey : **Family Wing**
Fun Water Jets
Splash Pool
Fun Pool
Robotayaki Dining
Play Area
Raised Sun Lawn
Korean Teppanyaki Dining
Charcoal & Grill Dining
Western Dining
- Leisure Wing**
Wet Sun Deck
50m-Lap Pool
Floating Pool Deck
Changing Rooms/Toilets
Water Jet Pool
Chill-Out Zone
Laundromat cum Lounge
Wine & Dine
Spa Pool Area Bar-Counter
360° Spa Pool with Spa Seats and Spa Beds
- (c) 24th storey : **Club Wing**
Alfresco Dining
The Italian Dining
Gourmet Kitchen
The Intimate Booth
The Wine Room
Recreation Corner
The Garden
The Living Room
- Wellness Wing**
Sky Gym
Outdoor Gym
Meditation Corner
Yoga Corner
Changing Room
Steam Room
Thermal Spa with Hot & Cold Jacuzzis
Massage/Aroma Therapeutic Deck

17. ADDITIONAL ITEMS

- (a) Kitchen Cabinets : High and low kitchen cabinets with compressed stone counter-tops
- (b) Kitchen Appliances : Cooker hood
Gas cooker hob for Kitchen/Wet kitchen (Excluding Unit Types S1, S2, S3, S4, A1 & A2 units)
Induction hob (For Unit Types S1, S2, S3, S4, A1 & A2 only)
Built-in oven (Excluding Unit Types S1, S2, S3, S4, A1 & A2 units)
Built-in steam oven (For Unit Type C1, C1S, D1, D1S, DP1, DP2, PH1, PH2 & PH3 only)
Built-in combination-oven (For Unit Types S1, S2, S3, S4, A1 & A2 only)
Built-in Refrigerator
Wine Chiller (For Unit Types DP1, DP2, PH1, PH2 & PH3 only)

- (c) Wardrobe : Built-in wardrobes are provided for all bedrooms
- (d) Air-Conditioning : Split unit air-conditioning system to Living/Dining, Family, Bedrooms, Study and Guestroom (Ducted air-conditioning system for Living/Dining and Master Bedroom – applicable to Penthouse and Duplex units only)
- (e) Hot Water Supply : Hot water supply to all Bathrooms, Kitchen, Dry Kitchen, Wet Kitchen and Powder Room (Excluding WC)
- (f) Gas : Town gas provided to Kitchen and Wet Kitchen (Excluding Unit Types S1, S2, S3, S4, A1 and A2)
- (g) Cable Vision : Provision of cable outlet only for Cable Vision services
- (h) Security System : Audio-Telephony system between visitor call panels and Apartment units shall be provided
Electronic Vehicular Access System of main entrance
Proximity Card access to all Communal Areas and Lift Lobby
CCTV Surveillance Camera at designated Communal Areas and Lift Lobby
- (i) Network Access : Wireless Network Access shall be provided at 1st storey, 5th storey and 24th storey
- (j) Wireless Music System : Wireless Multi-Room Music System shall be provided to Living/Dining and Master Bedroom only

18. OTHERS

- (a) Air-conditioning system
To ensure good working condition of the air-conditioning system, the system has to be maintained and cleaned by the Purchaser on a regular basis. This includes the cleaning of filters, clearing the condensate pipes and charging of gas.
- (b) Cable Television and/or Internet Access
The Purchaser is liable to pay annual fee, subscription fee and such other fees to the *StarHub Cable Vision Ltd (SCV) and/or internet service providers (ISP) or any other relevant party or any other relevant authorities. The Vendor is not responsible to make arrangements with any of the said parties for the service connection for their respective *subscription channels and/or internet access.
- (c) Materials, Fittings, Equipment, Finishes, Installations and Appliances
Subject to Clause 14.3 the brand, colour and model of all materials, fittings, equipment, finishes, installations and appliances supplied shall be provided subject to Architect's selection, market availability and the sole discretion of the Vendor.
- (d) Marble, Limestone and Granite
Marble, limestone and granite are natural stone materials containing veins with tonality differences. There will be colour and markings caused by their complex mineral composition and incorporated impurities. While such materials can be pre-selected before installation, this non-conformity in the marble, limestone or granite as well as non-uniformity between pieces cannot be totally avoided. Granite tiles are pre-polished before laying and care has been taken for their installation. However granite, being a much harder material than marble cannot be re-polished after installation. Hence some differences may be felt at the joints. *Subject to Clause 14.3, the tonality and pattern of the marble, limestone or granite selected and installed shall be subject to availability.
- (e) Wardrobes, Kitchen Cabinets, Fan Coil Units, Electrical Points, Door Swing Positions and Plaster Ceiling Boards
Layout/location of wardrobes, kitchen cabinets, fan coil units, electrical points, door swing positions and plaster ceiling boards are subject to Architect's sole discretion and final design.
- (f) Warranties
Where warranties are given by the manufacturers and/or contractors and/or suppliers of any of the equipment and/or appliances installed by the Vendor at the Unit, the Vendor shall assign to the Purchaser such warranties at the time when possession of the Unit is delivered to the Purchaser.
- (g) Timber
Timber is a natural materials containing *grain/vein and tonal differences. Thus it is not possible to achieve total consistency of colour and grain in its selection and installation.
- (h) Wall
No tiles behind/below kitchen cabinet, long bath and mirror.
Wall surface above the false ceiling level shall be left in its original bare condition.
- (i) Planter
Planters are designed for potted plants only. No soil material or turf/plants will be provided to planters.
- (j) Tiles
Selected tile sizes and tile surface flatness cannot be perfect and are subject to manufacturing and acceptable range described in Singapore Standards SS483:2000.
- (k) Glass
Glass is a manufactured material that is not 100% pure. Invisible nickel sulphide impurities may cause spontaneous glass breakage, which may occur in all glass by all manufacturers. The Purchaser is recommended to take up home insurance covering glass breakage to cover this possible event.
- (l) False Ceiling
The space provision allows for the optimal function and installation of M&E services. Access panels are allocated for ease of maintenance access to concealed M&E equipment for regular cleaning purpose. Where removal of equipment is needed, ceiling works would be required. Location of false ceiling is subject to Architect's sole discretion and final design.